

S1

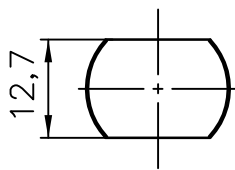

S6

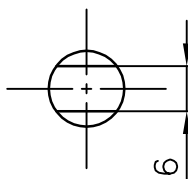

S9

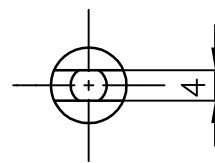

S23

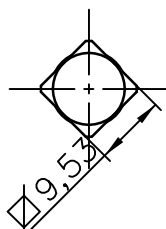
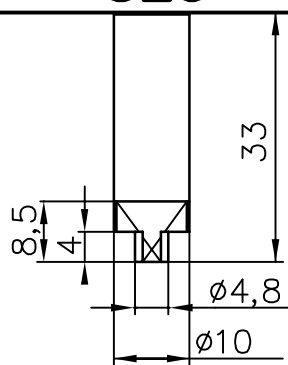
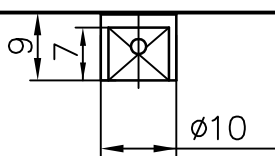
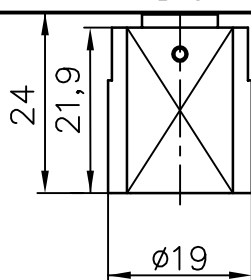
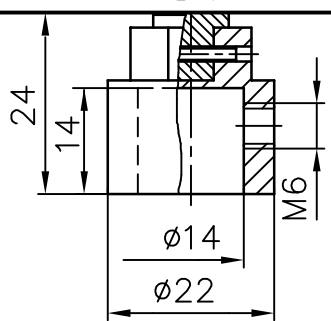

S26

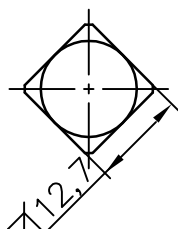

S30

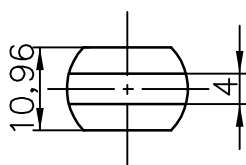

S36

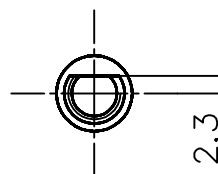

S39

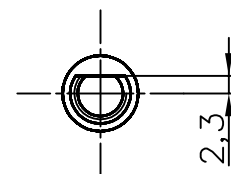

S39L

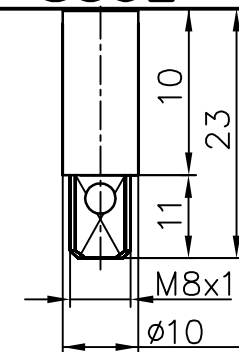
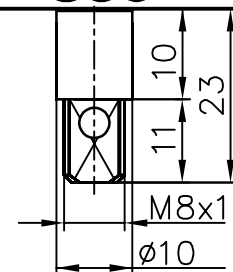
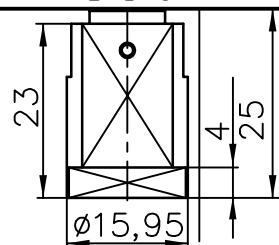
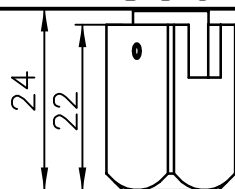
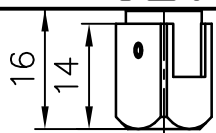

Note 1: S9, S23, S39, and S39L are solid spindles.

S1, S6, S26, S30, and S36 are adapters to fit on Spindle S9.

Note 2: S39L for D3F/Logix800-16 only.

		D3/Logix 800			
PART NO.	PCS	DESCRIPTION	MATERIAL	DIMENSION	ANNOTATION
HOLE TOL.		UNSPECIFIED TOLERANCES ACCORDING TO:	SURFACE	PROJECTION EUROPA	
H13		ISO 2768-m	Ra: 6,3		
		PMV DRIVESHAFT DIMENSION DRAWING		DRW BY	APPR. BY
				MRn	
		SCALE	DATE		
			080128		
PALMSTIERNA INTERNATIONAL AB				DRAWING NO.	
				SPNDLS_D3	
KORTA GATAN 9 SE-171 54 SOLNA SWEDEN - Tel:+46(0)8 555 106 00-Fax:+46(0)8 555 106 01 - www.pmv.nu					

This document must not be copied without our written permission and the contents thereof must not be imparted to a third party nor be used for any unauthorized purpose. Contravention will be prosecuted.